





PS15



PS15

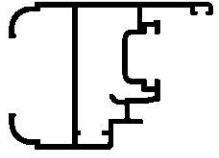
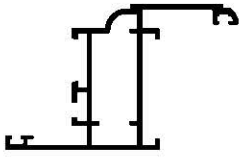
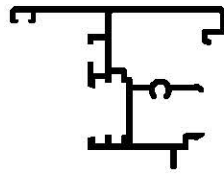
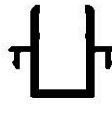

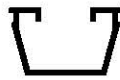
PROFILI

Kod Codice Code	Presjek Sezione Cross Section	Težina Peso Weight <i>Kg/m</i>	Perimetar Perimetro Perimeter mm	Vidljiva površina Sup. in Vista Exposed surface mm	Jx <i>cm⁴</i>	Wx <i>cm³</i>	Jy <i>cm⁴</i>	Wy <i>cm³</i>
PS15005		1.042	530.7	138.03	12.02	4.43	10.09	2.76
PS15006		0.978	488.2	121.44	11.97	4.95	10.67	2.68
PS15007		0.878	433.06	93.782	7.41	2.61	6.62	1.92
PS15008		0.394	163.25	35.94	0.7	0.5	0.87	0.62
PS15003		0.382	230.6	107.38	3.02	1.11	0.33	0.49
PS15004		0.484	304.9	117.5	7.37	2.18	0.47	0.49
PS15061		0.216	134.5	31.6	0.29	0.35	0.68	0.50
PS15060		0.509	261.9	206.2	4.93	5.47	0.38	0.12

PROFILI

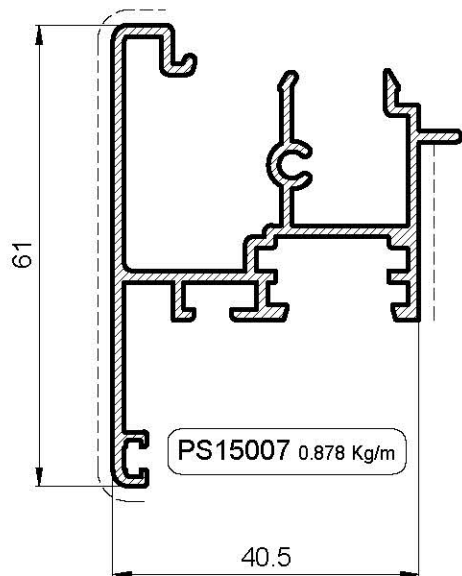
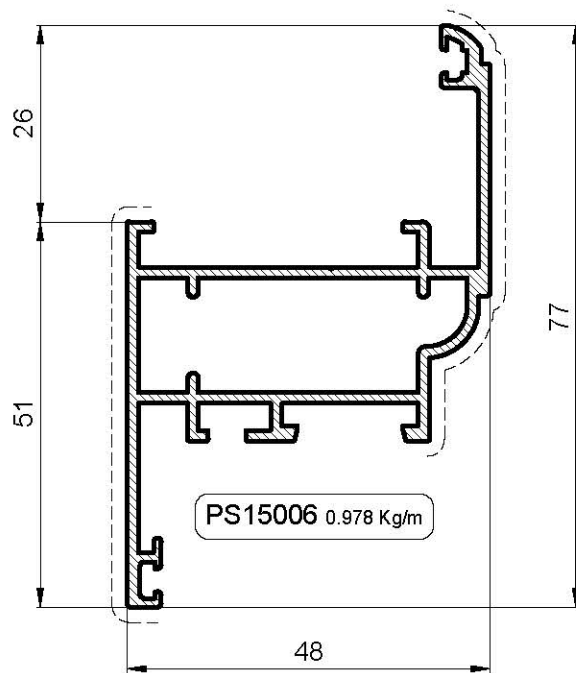
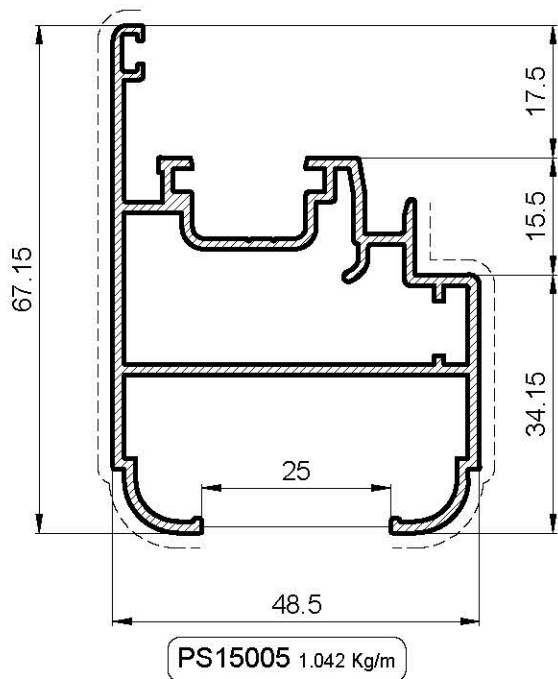

PROFILI

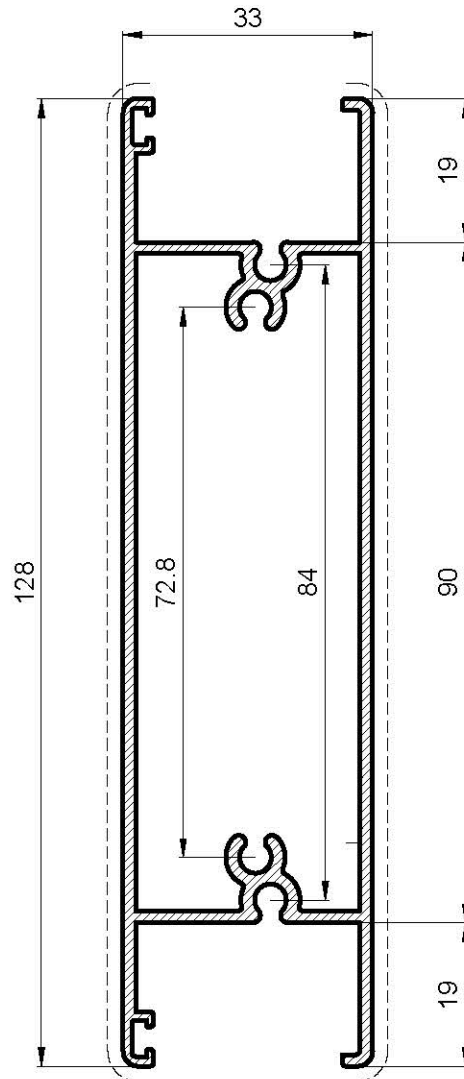

PS15600 1.663 Kg/m

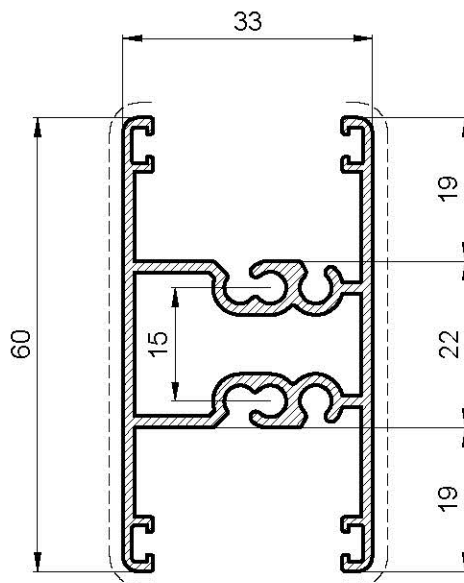

PS15062 0.954 Kg/m

PROFILI

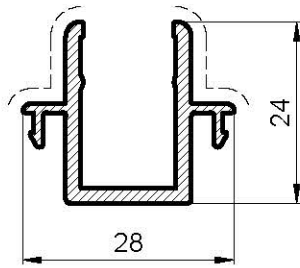

PS15008 0.394 Kg/m

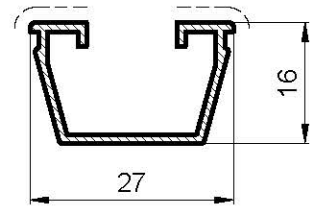

PS15061 0.216 Kg/m

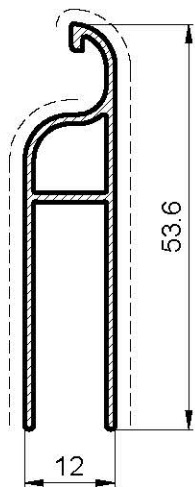

PS15003 0.382 Kg/m

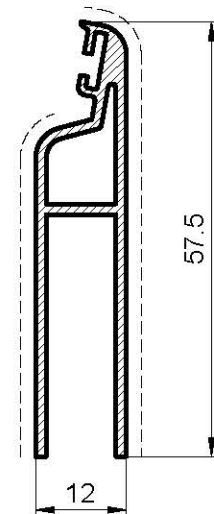

PS15060 0.509 Kg/m

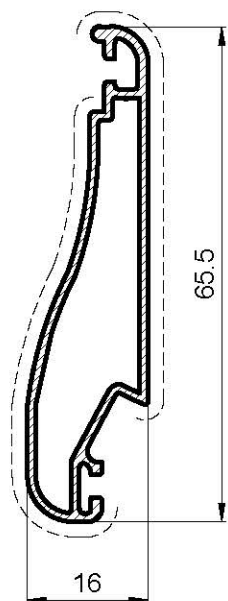

PS15004 0.484 Kg/m

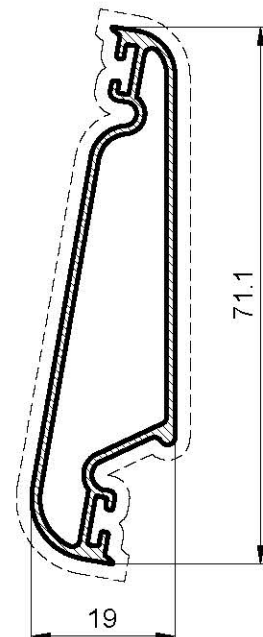

PS01381 0.530 Kg/m

PRESJECI

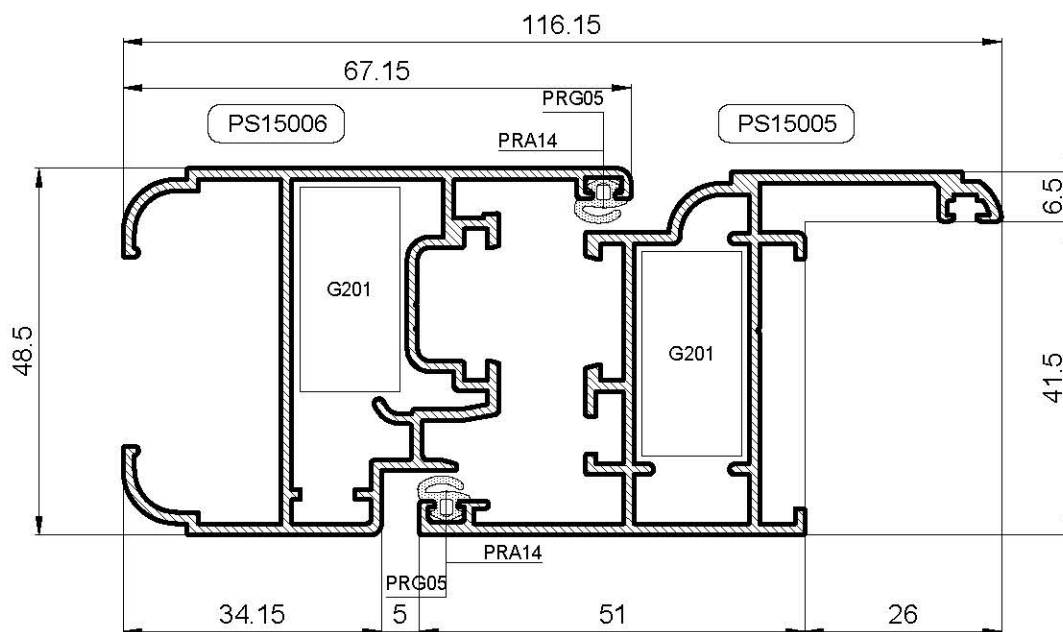
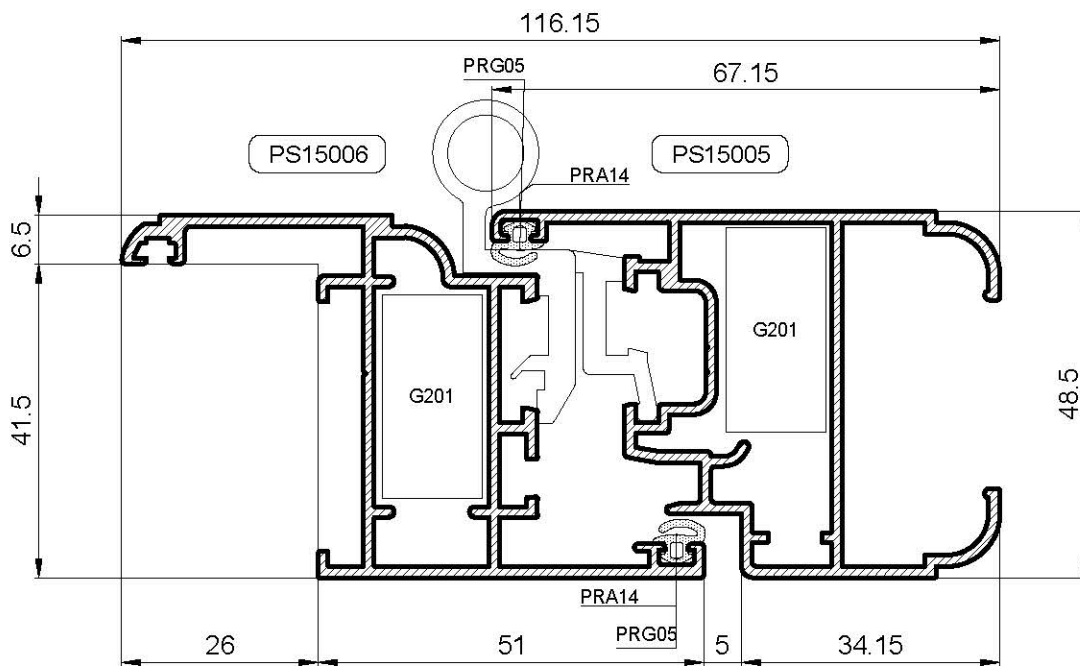
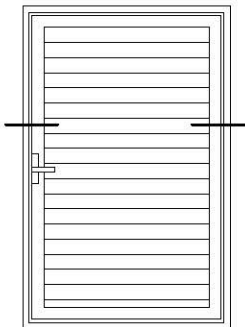

PRESJECI

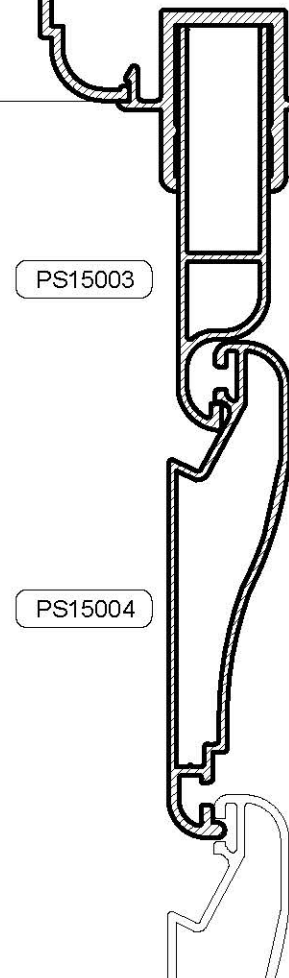
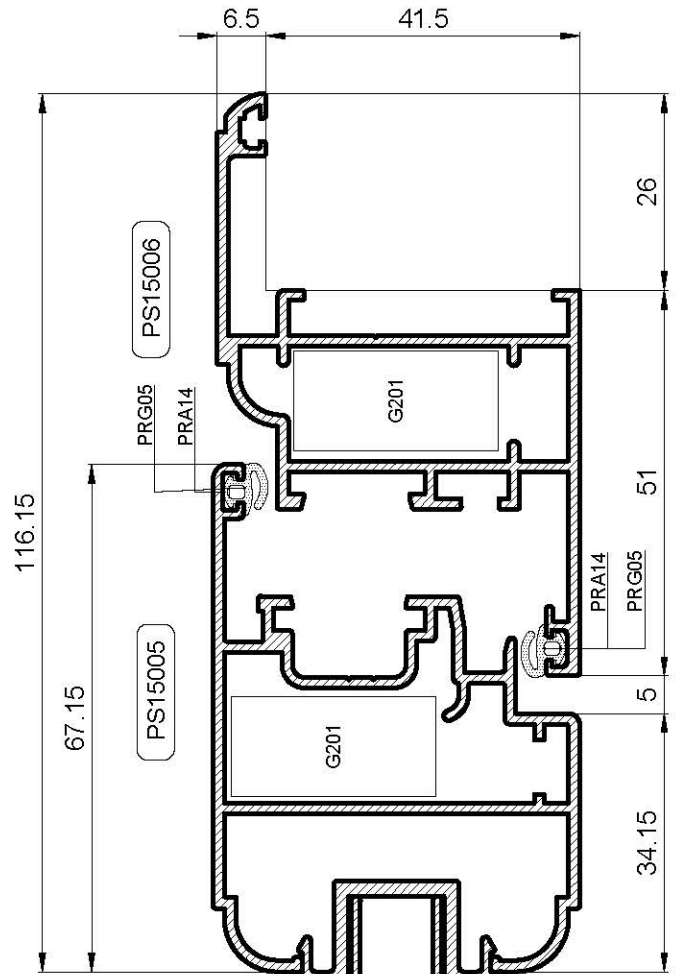
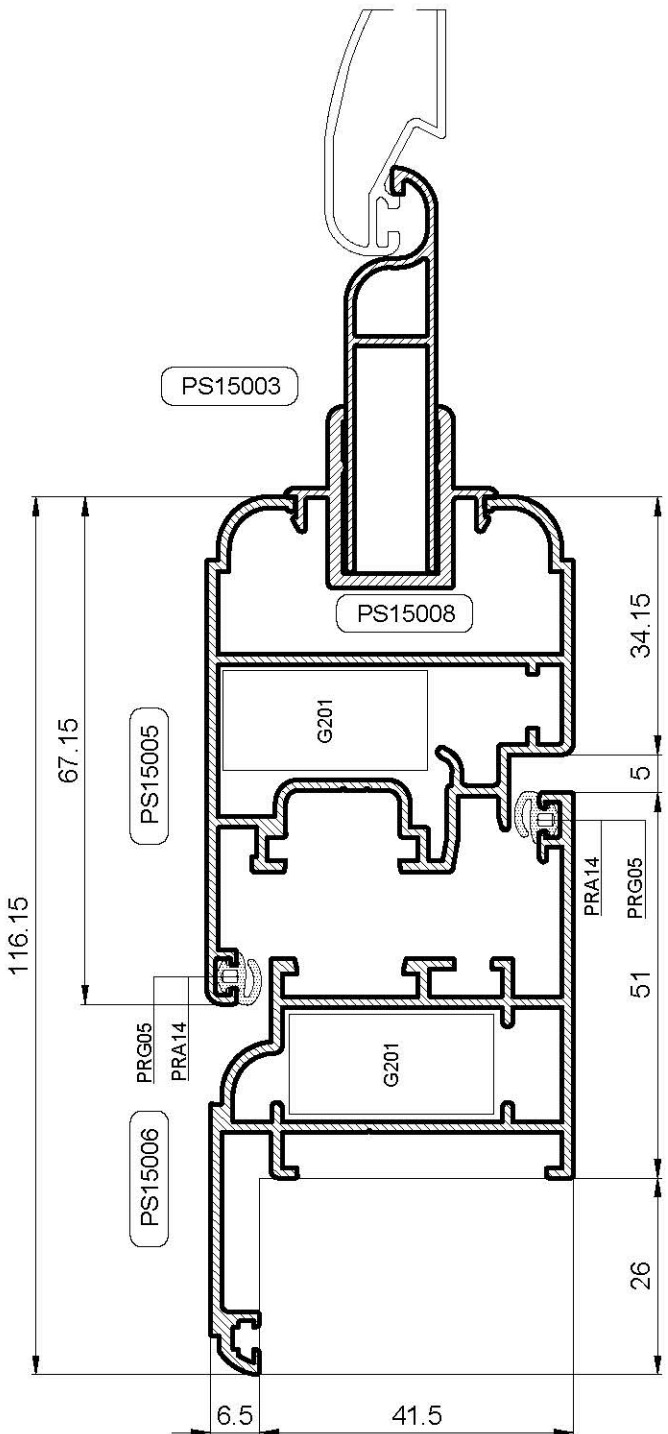
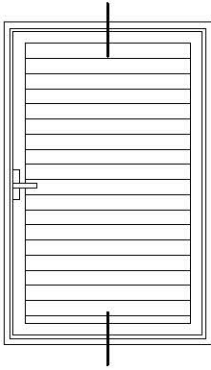

PRESJECI

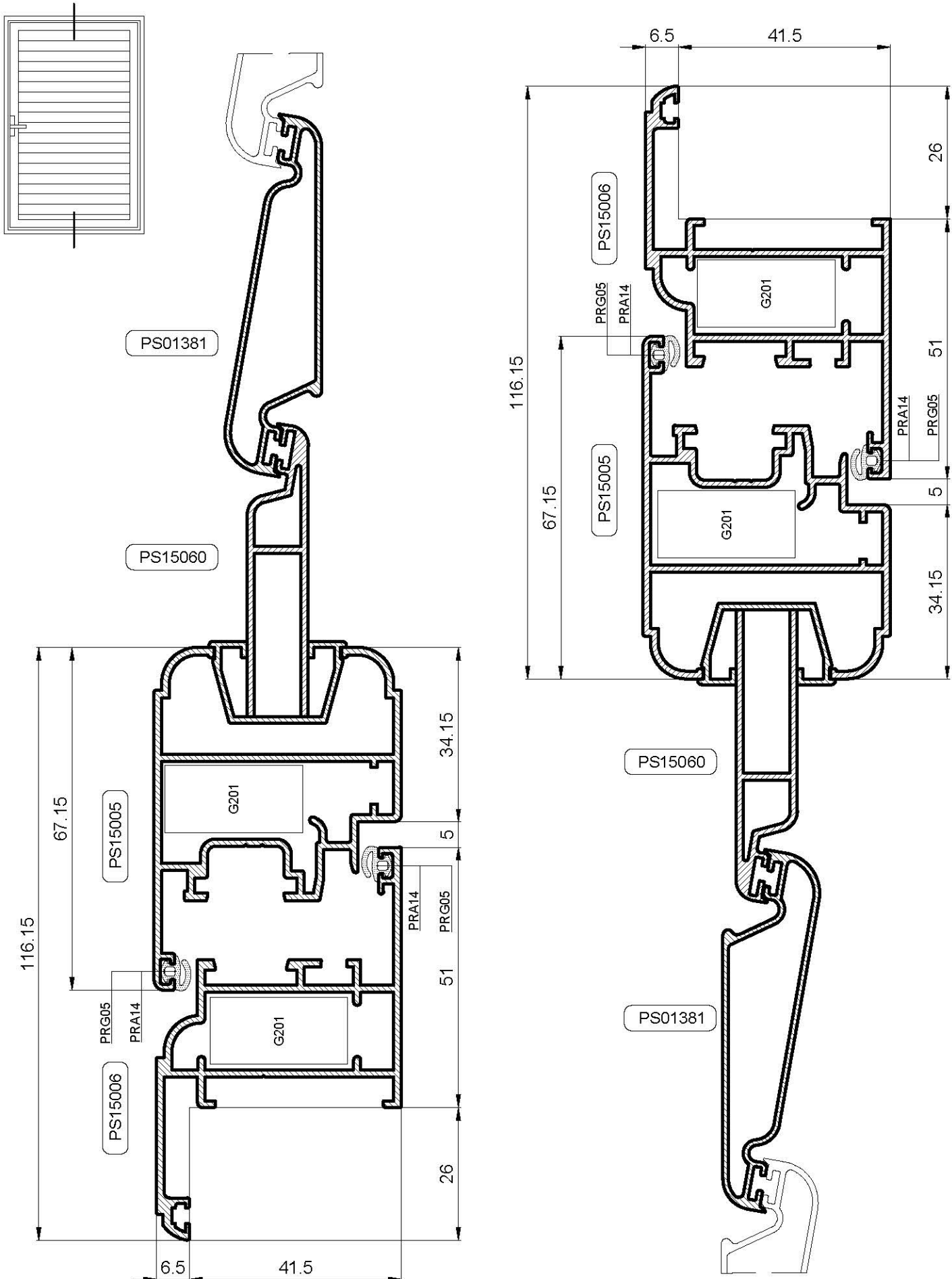

PRESJECI

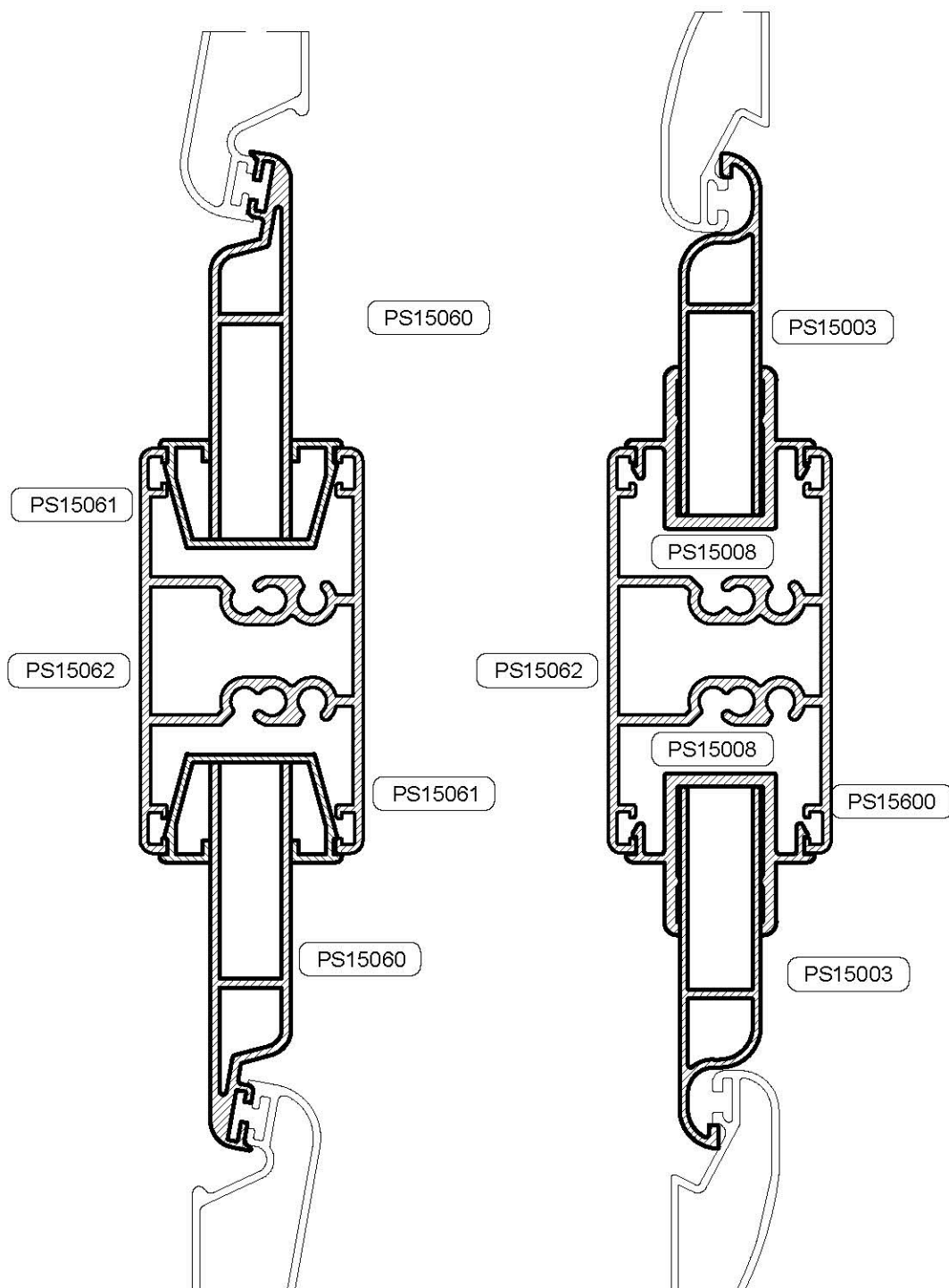
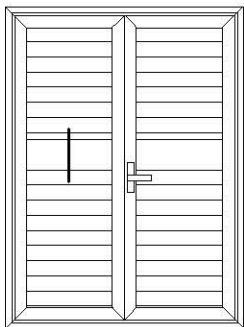

PRESJECI

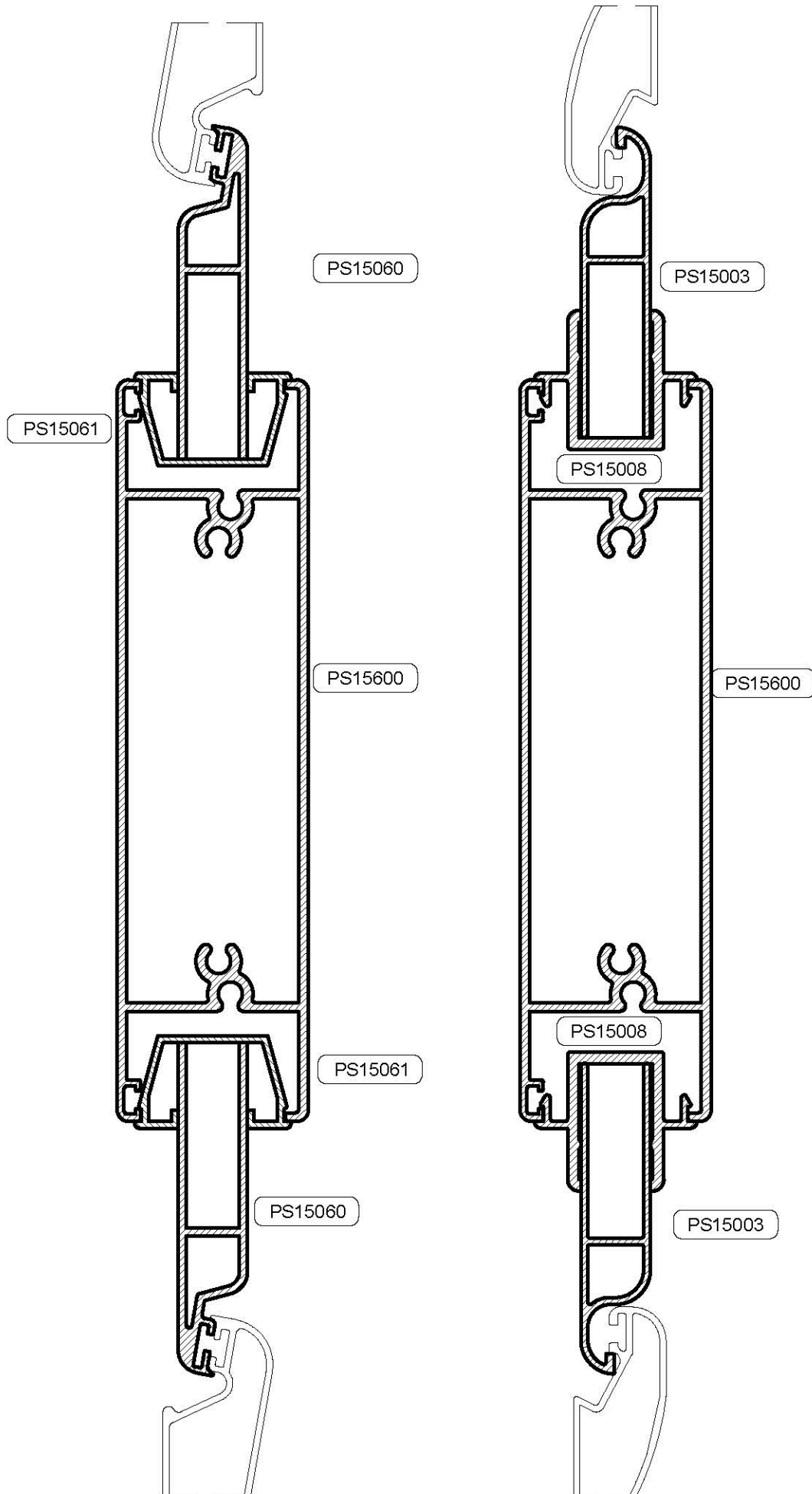
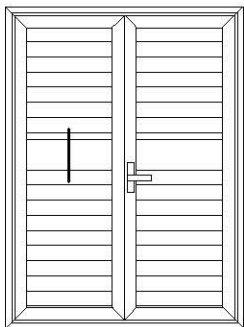

PRESJECI

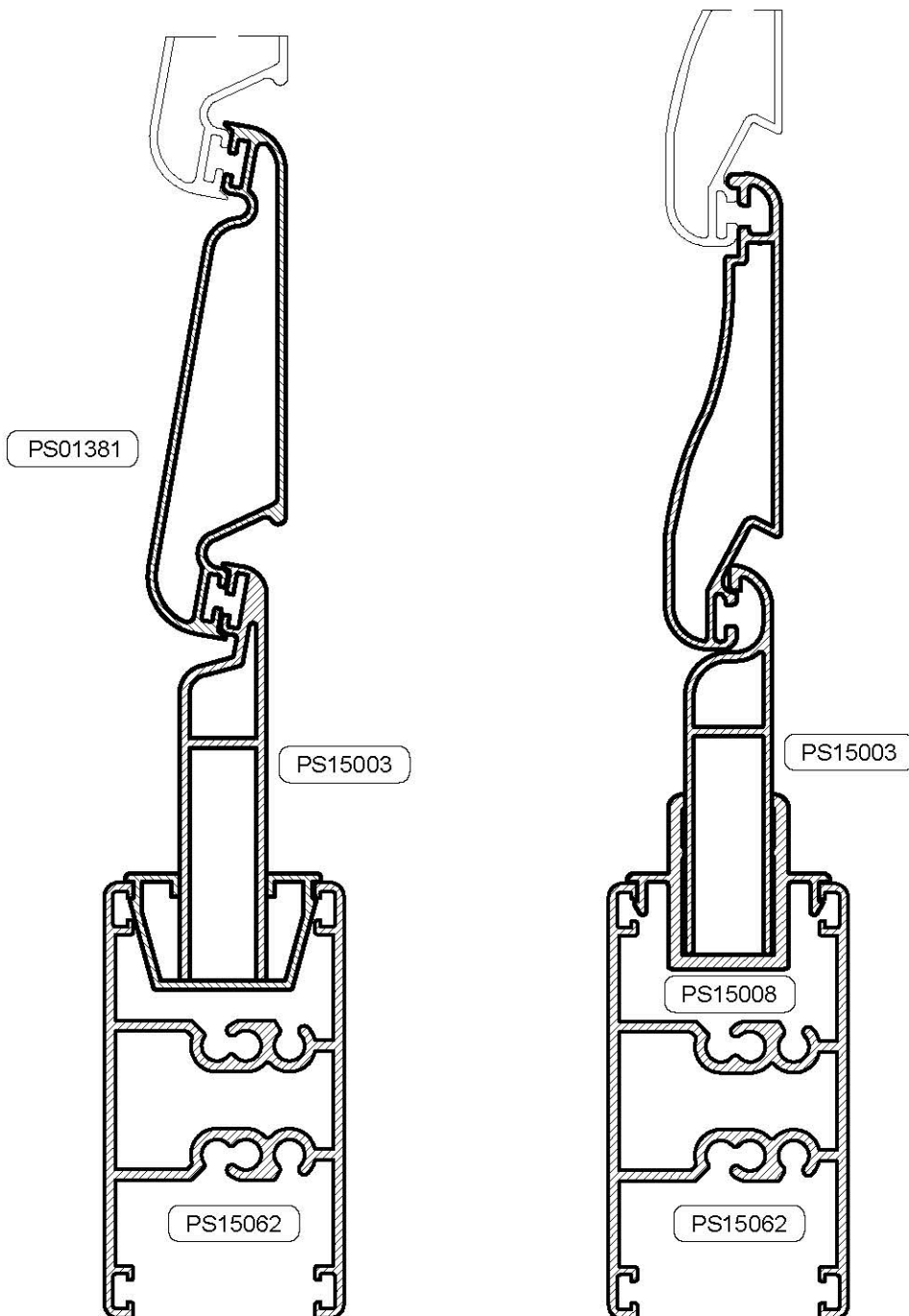
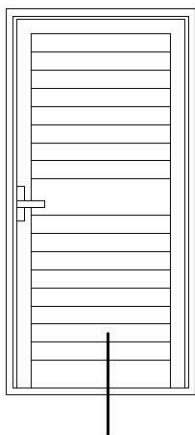

REZNE LISTE - Jednokrilna grilja

KOD	PROFIL	BR. KOM	REZANJE
PS 15006	OKOMICA OKVIRA	2	
PS 15006	GORNJA VODORAVNICA OKVIRA	1	
PS 15006	DONJA VODORAVNICA OKVIRA	1	
PS 15005	OKOMICA KRILA	2	
PS 15005	VODORAVNICA KRILA	2	
PS 15008	NOSAČ POČETNE LAMELE	2	
PS 15003	POČETNA LAMELA	2	
PS 15004	LAMELA	N	

KOD	OKOVI	BR. KOM	NOTE
G 201	KUTNIK OKVIRA/KRILA	8	
PRA 14	KUTNIK PORAVNANJA KRILA	8	

KOD	BRTVE/ČEPOVI	BR. KOM	NOTE
Z106	UNUTARNJA BRTVA KRILA	8	4L + 4H

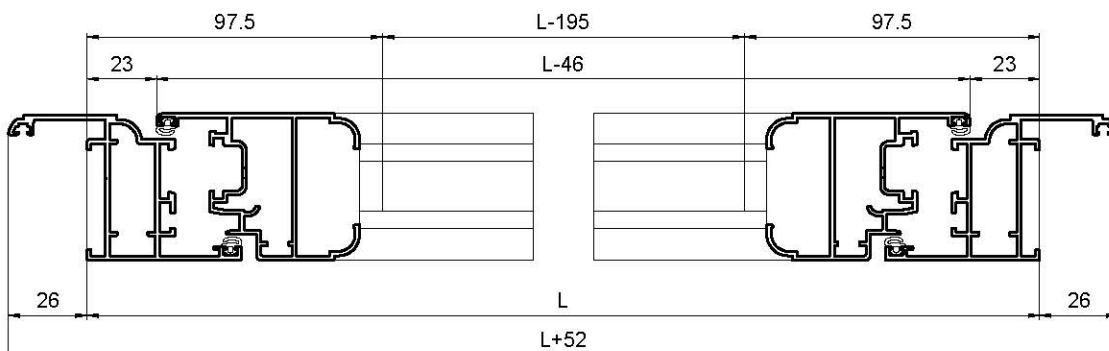
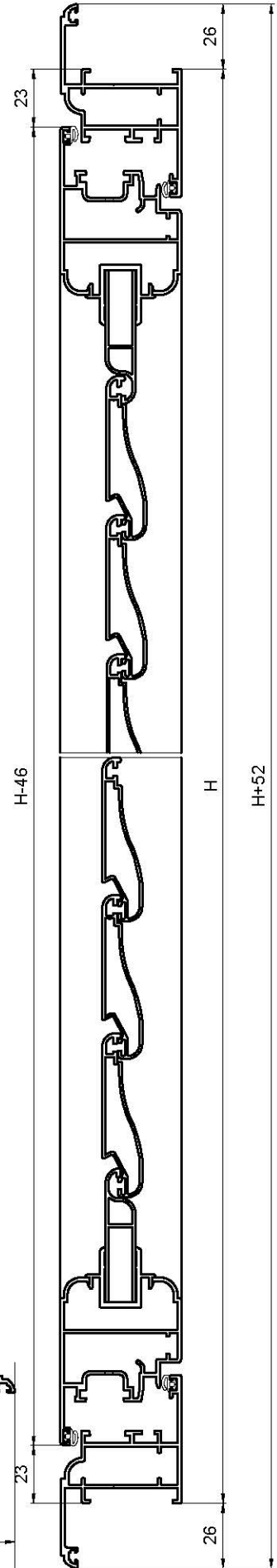
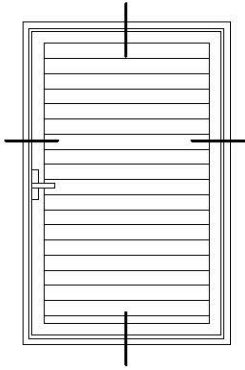
REZNE LISTE - Jednokrilna grilja

REZNE LISTE - Dvokrilna grilja

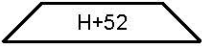
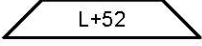
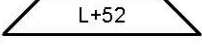
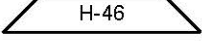
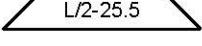
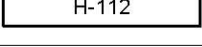
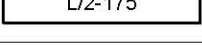
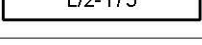
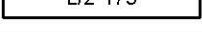
KOD	PROFIL	BR. KOM	REZANJE
PS 15006	OKOMICA OKVIRA	2	
PS 15006	GORNJA VODORAVNICA OKVIRA	1	
PS 15006	DONJA VODORAVNICA OKVIRA	1	
PS 15005	OKOMICA KRILA	4	
PS 15005	VODORAVNICA KRILA	2	
PS 15007	CENTRALNI PROFIL	1	
PS 15008	NOSAČ POČETNE LAMELE	4	
PS 15003	POČETNA LAMELA	4	
PS 15004	LAMELA	N	

KOD	OKOVI	BR. KOM	NOTE
G 201	KUTNIK OKVIRA/KRILA	12	
PRA 14	KUTNIK PORAVNANJA KRILA	12	
GS2273	KAPA ZA CENTRALNI PROFIL GRILJE	1	

KOD	BRTVE/ČEPOVI	BR. KOM	NOTE
Z106	UNUTARNJA BRTVA KRILA	11	4L + 7H

REZNE LISTE - Dvokrilna grilja

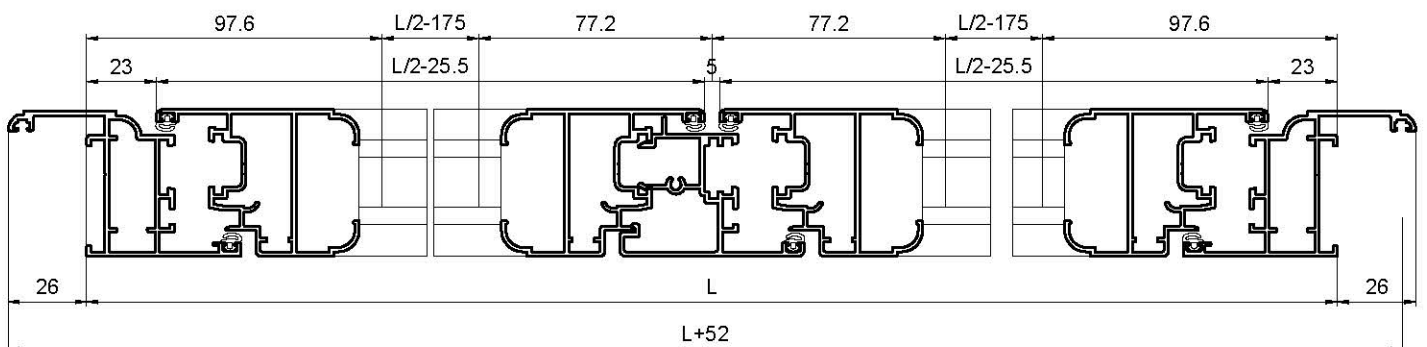
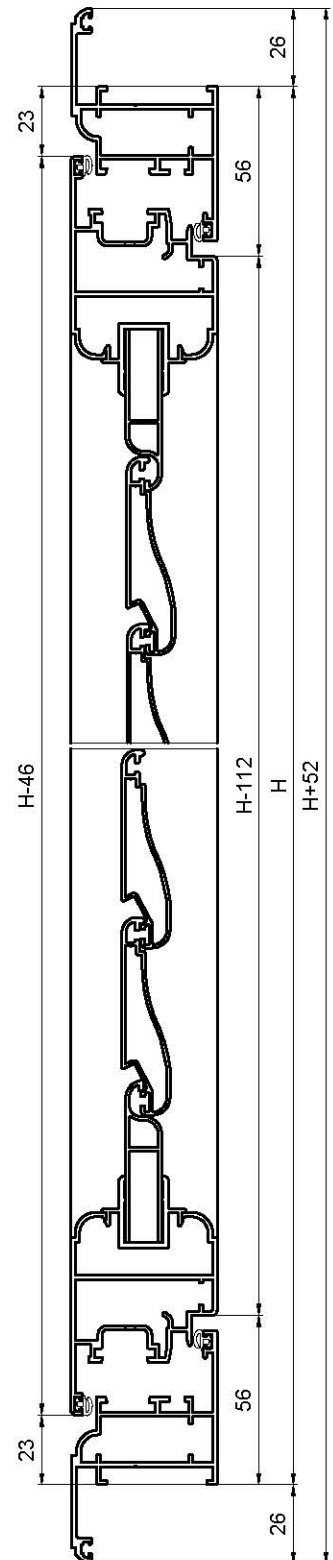
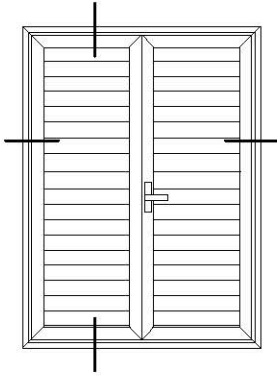

REZNE LISTE - Jednokrilna grilja

KOD	PROFIL	BR. KOM	REZANJE
PS 15006	OKOMICA OKVIRA	2	
PS 15006	GORNJA VODORAVNICA OKVIRA	1	
PS 15006	DONJA VODORAVNICA OKVIRA	1	
PS 15005	OKOMICA KRILA	2	
PS 15005	VODORAVNICA KRILA	2	
PS 15061	NOSAČ POČETNE LAMELE	2	
PS 15060	POČETNA LAMELA	2	
PS 01381	LAMELA	N	

KOD	OKOVI	BR. KOM	NOTE
G 201	KUTNIK OKVIRA/KRILA	8	
PRA 14	KUTNIK PORAVNANJA KRILA	8	

KOD	BRTVE/ČEPOVI	BR. KOM	NOTE
PRG 05	UNUTARNJA BRTVA KRILA	8	4L + 4H

REZNE LISTE - Jednokrilna grilja

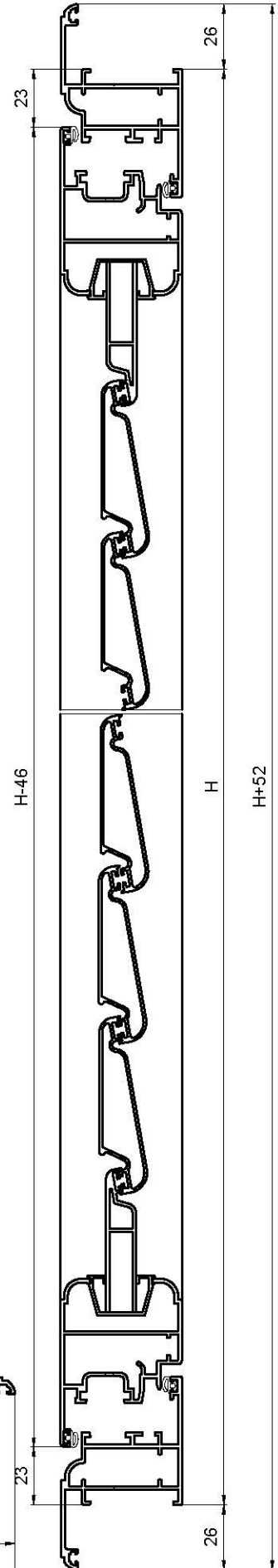
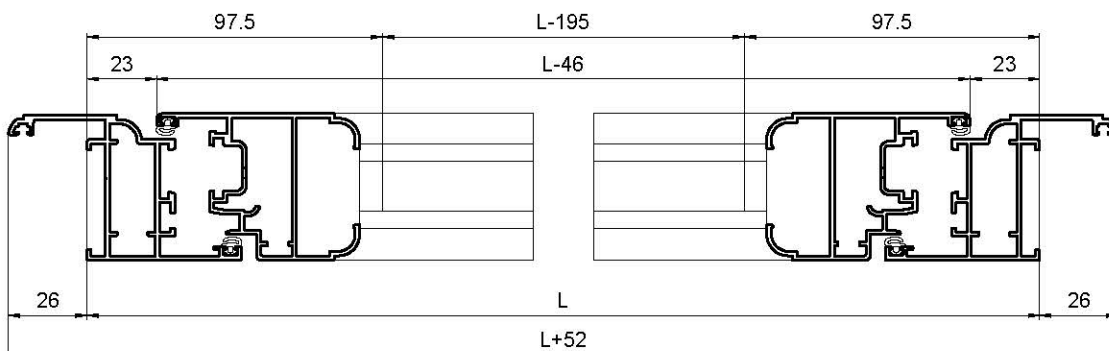
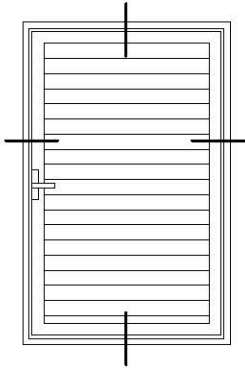

REZNE LISTE - Dvokrilna grilja

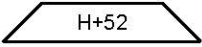
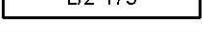
KOD	PROFIL	BR. KOM	REZANJE
PS 15006	OKOMICA OKVIRA	2	
PS 15006	GORNJA VODORAVNICA OKVIRA	1	
PS 15006	DONJA VODORAVNICA OKVIRA	1	
PS 15005	OKOMICA KRILA	4	
PS 15005	VODORAVNICA KRILA	2	
PS 15007	CENTRALNI PROFIL	1	
PS 15061	NOSAČ POČETNE LAMELE	4	
PS 15060	POČETNA LAMELA	4	
PS 01381	LAMELA	N	

KOD	OKOVI	BR. KOM	NOTE
G 201	KUTNIK OKVIRA/KRILA	12	
PRA 14	KUTNIK PORAVNANJA KRILA	12	
GS2273	KAPA ZA CENTRALNI PROFIL GRILJE	1	

KOD	BRTVE/ČEPOVI	BR. KOM	NOTE
PRG 05	UNUTARNJA BRTVA KRILA	11	4L + 7H

REZNE LISTE - Dvokrilna grilja

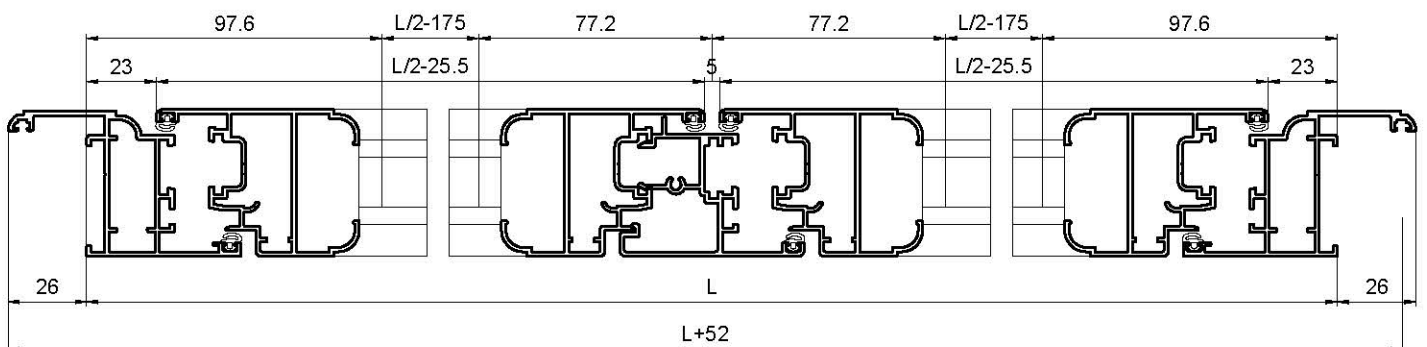
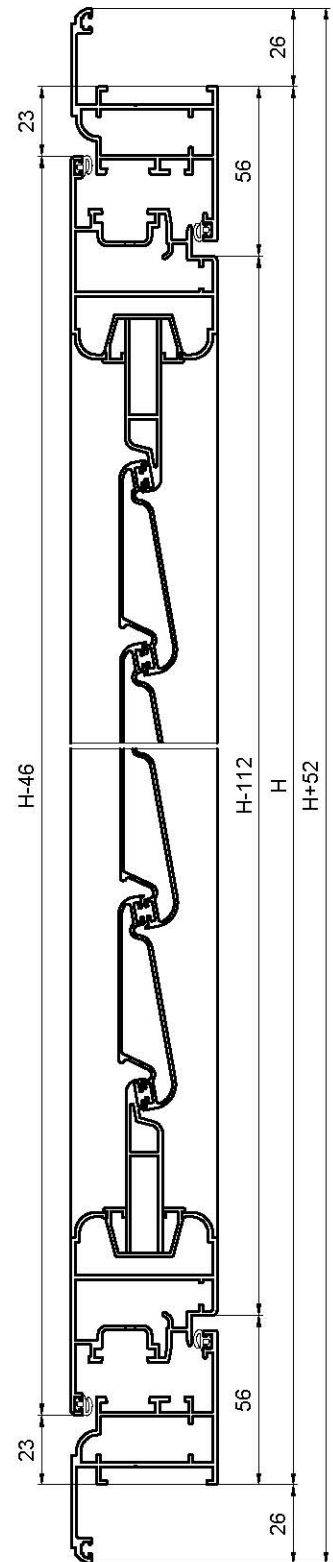
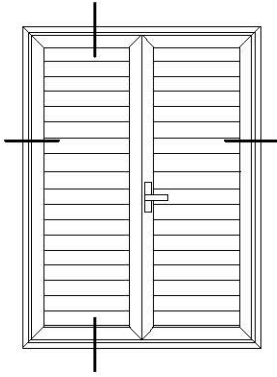

REZNE LISTE - Jednokrilna grilja

KOD	PROFIL	BR. KOM	REZANJE
PS 15006	OKOMICA OKVIRA	1L 1D	 H+26
PS 15006	GORNJA VODORAVNICA OKVIRA	1	 L+52
PS 15005	OKOMICA KRILA	1L 1D	 H-29
PS 15005	VODORAVNICA KRILA	1	 L-46
PS 15062	PARAPET	2	 L-139
PS 15008	NOSAČ POČETNE LAMELE	4	 L-195
PS 15003	POČETNA LAMELA	4	 L-195
PS 15004	LAMELA	N	 L-195

KOD	OKOVI	BR. KOM	NOTE
G 201	KUTNIK OKVIRA/KRILA	4	
PRA 14	KUTNIK PORAVNANJA KRILA	4	

KOD	BRTVE/ČEPOVI	BR. KOM	NOTE
PRG 05	UNUTARNJA BRTVA KRILA	6	2L + 4H

REZNE LISTE - Jednokrilna grilja

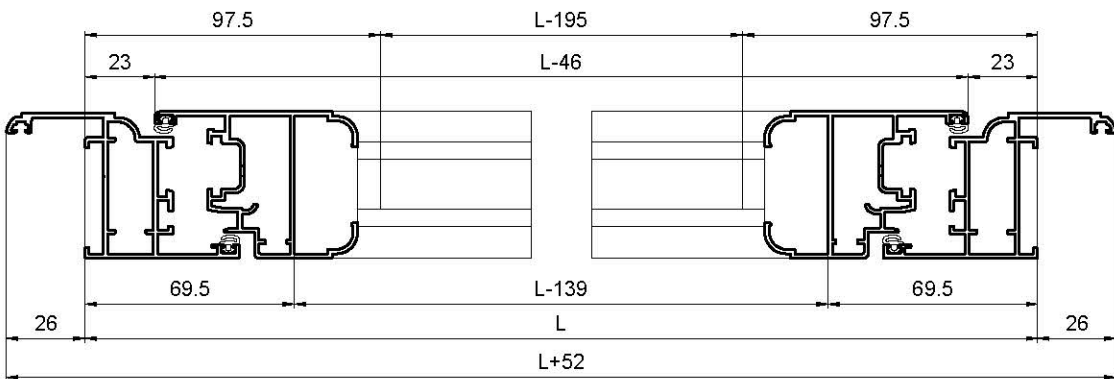
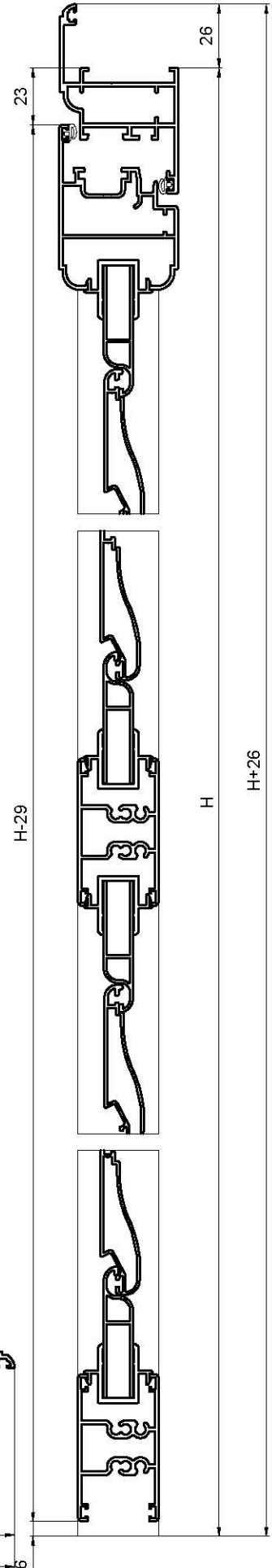
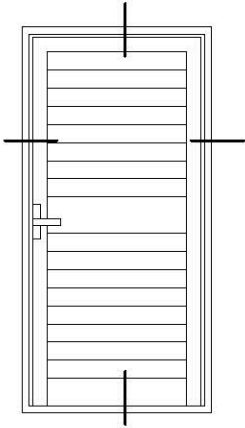

REZNE LISTE - Jednokrilna grilja

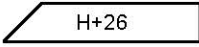
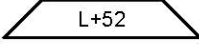
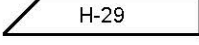
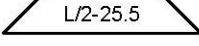
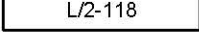
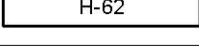
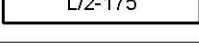
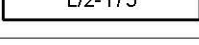
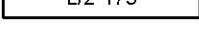

KOD	PROFIL	BR. KOM	REZANJE
PS 15006	OKOMICA OKVIRA	2	 H+26
PS 15006	GORNJA VODORAVNICA OKVIRA	1	 L+52
PS 15005	OKOMICA KRILA	4	 H-29
PS 15005	VODORAVNICA KRILA	2	 L/2-25.5
PS 15062	PARAPET	4	 L/2-118
PS 15007	CENTRALNI PROFIL	1	 H-62
PS 15008	NOSAČ POČETNE LAMELE	4	 L/2-175
PS 15003	POČETNA LAMELA	4	 L/2-175
PS 15004	LAMELA	N	 L/2-175

KOD	OKOVI	BR. KOM	NOTE
G 201	KUTNIK OKVIRA/KRILA	6	
PRA 14	KUTNIK PORAVNANJA KRILA	6	
GS2273	KAPA ZA CENTRALNI PROFIL GRILJE	1	

KOD	BRTVE/ČEPOVI	BR. KOM	NOTE
PRG 05	UNUTARNJA BRTVA KRILA	9	2L + 7H

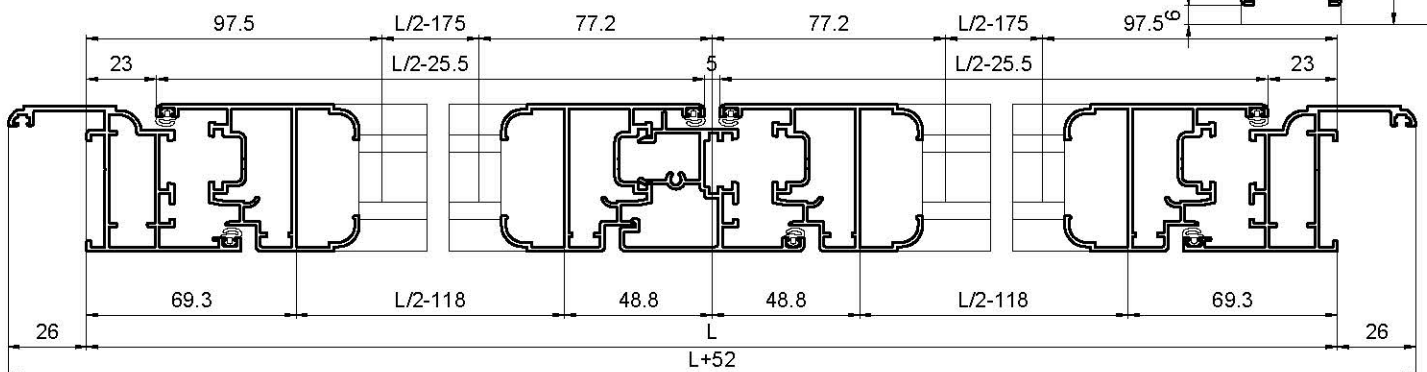
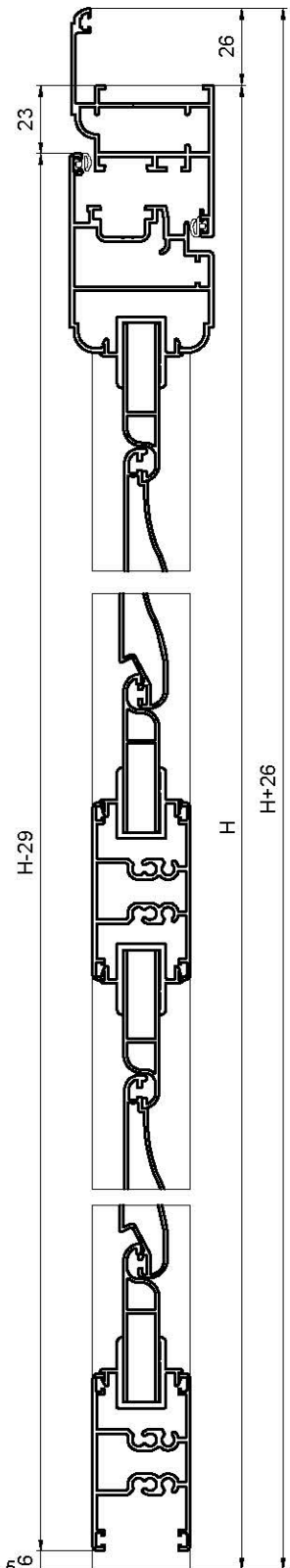
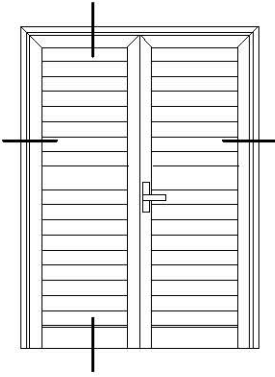
REZNE LISTE - Dvokrilna grilja

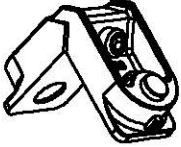

BRTVE I OKOVI										
Codice Code Kod	Sezione Section Sezione	Descrizione Description Opis	Quantità Box Quantity Kom/Pak			Materiale Material Materijal				
PRG05		Brtva krila	600			EPDM / DUTRAL				
G 201		Kutnik sa dugmetom 28.5 mm x 14.5 mm				Aluminijski odlivak				
PRA14		Kutnik poravnanja INOX				Nehrđajući čelik				