

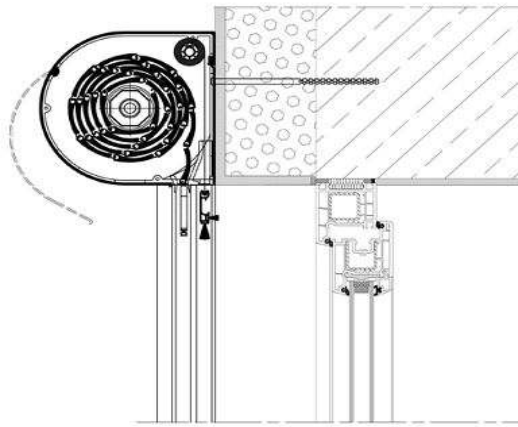

ROLETNA CJENOVNIK ZA 2021 GODINU

ALUMIL



EURO-ROAL doo  
Sarajevska 17,  
74 203 Doboj Jug  
tel 032-692-518  
info@euroroal.ba

EURO-ROAL doo  
Garovci bb  
Hadžići  
tel 033-420-499  
info1@euroroal.ba

EURO-ROAL doo  
Ostrožac bb  
Cazin  
tel 037-518-219  
hase.h@euroroal.ba

# ALUMIL

## ROLETNA CJENOVNIK ZA 2020 GODINU

### KUTIJA EXTRUDIRANA 154X145 ALUMIL

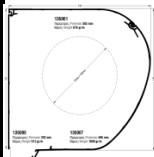

SIFRA ART	BOJA	DUZINA
10342/38/40	BIJELA	L-6000
10341/37/39	SIVA	L-6000
10562/60/61	BRAON	L-6000

### KUTIJA EXTRUDIRANA 183X180 ALUMIL

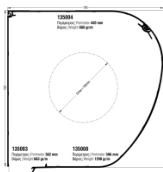

SIFRA ART	BOJA	DUZINA
10348/44/46	BIJELA	L-6000
10347/43/45	SIVA	L-6000
10565/63/64	BRAON	L-6000

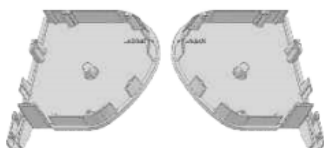

### DEKLO 154X145/183X180 ALUMIL

SIFRA ART.	BOJA
10277/10278	BIJELA
10598/10599	SIVA
11060/11061	BRAON



SIFRA ART	OPIS
11060	SIGURNOSNI LIM 154x145 ALUMIL
11061	SIGURNOSNI LIM 183X180 ALUMIL

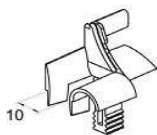

SIFRA ART.	OPIS
38044	PVC VOĐICA ALUPROF

### VODILICE ZA ROLETNU JEDNODJELNE

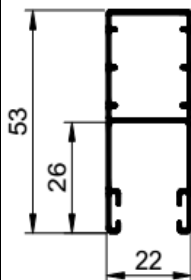

SIFRA ART	BOJA	DUZINA
12101	BIJELA	L-6000
12100	SIVA	L-6000
12102	BRAON	L-6000
11658	ZLATNI HR.	L-6000
12104	ANTRACIT	L-6000

### VODILICE DVODJELNE ZA ROLETNU I KOMARNIK

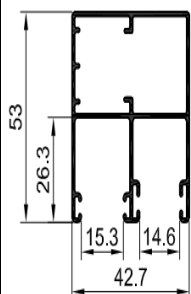

SIFRA ART	BOJA	DUZINA
38025	BIJELA	L-6000
38024	SIVA	L-6000
38049	BRAON	L-6000
38193	RAL 8019	L-6000
38070	ANTRACIT	L-6000
38105	ZLATNI HR	L-6000

### VODILICE DVODJELNE ZA ROLETNU (H-VODILICA)

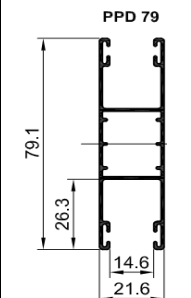

SIFRA ART	BOJA	DUZINA
38178	BIJELA	L-6000
38030	SIVA	L-6000
38031	BRAON	L-6000
38180	RAL 8019	L-6000
38179	ANTRACIT	L-6000
	ZLATNI HR	L-6000

### GRANIČNI PROFIL ZA LAMELU (POČETNA)



SIFRA ART	BOJA	DUZINA
38035	BIJELA	L-6000
38000	SIVA	L-6000
38036	BRAON	L-6000
38176	RAL 8019	L-6000
38064	ANTRACIT	L-6000
38123	ZLATNI HR	L-6000

### GRANIČNI PROFIL ZAKOMARNIK INTEGRISANI ALUPROF (POČETNA)

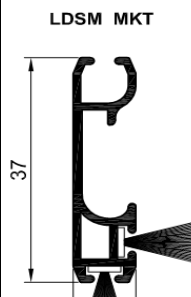

SIFRA ART	BOJA	DUZINA
38020	BIJELA	L-6000
38019	SIVA	L-6000
38052	BRAON	L-6000
38196	RAL 8019	L-6000
38130	ANTRACIT	L-6000
38112	ZLATNI HR	L-6000

ALUMINIJSKA LAMELA H39 ALUPROF

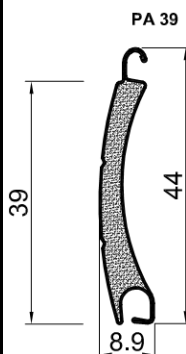

SIFRA ART	BOJA	DUZINA
38035	BIJELA	L6500
38000	SIVA	L6500
38036	BRAON	L6500
38176	RAL 8019	L6500
38064	ANTRACIT	L6500
38123	ZLATNI HR	L6500
38053	MAHAGONI	L6500

ALUMINIJSKA LAMELA H39 AS

32000	BIJELA	L6500
32001	SIVA	L6500
32002	BRAON	L6500
32317	ANTRACIT	L6500
32070	ZLATNI HR	L6500

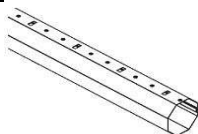

SIFRA ART	OPIS
10212	OKTAGONALNA CIJEV FI 40

RNS MKT



SIFRA ART	OPIS
38021	MREZA ZA INTEG.ROLO KOMARNIK 1600X6000 APF
38022	MREZA ZA INTEG.ROLO KOMARNIK 2500X6000 APF

PA 39

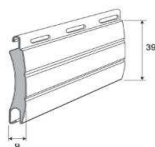

Stupac1	Stupac2
Težina 1m2=2,8 kg	
Debljina= 9mm	
Broj lamela na 1m visine=25,6kom	
Max površina=6m2	
Visina profila=39mm	



SIFRA ART	OPIS
50114	ČETKICA 67X60



SIFRA ART	OPIS
50896	GUMA ZA GRANIČNI PROFIL



SIFRA ART	OPIS
50254	POKLOPAC LAMELE H39

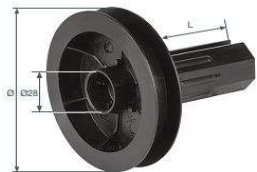

SIFRA ART	OPIS
50490	KOTUR 120
50491	KOTUR 140



SIFRA ART	OPIS
50492	OKTAGON POKLOPAC PVC 40mm LOF

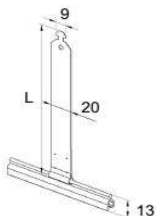

SIFRA ART	OPIS
50159	KONEKTOR LAMELE SA PLASTIKOM

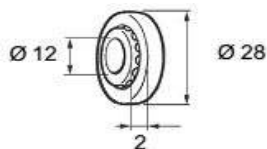

SIFRA ART	OPIS
10285	LEŽAJ



SIFRA ART	OPIS
50428	VANJSKI STOPER SVE BOJE



SIFRA ART	OPIS
50386	SKRIVENI STOPER



SIFRA ART	OPIS
10273	KOČNICA BEZ ZAKLUČAVANJA



SIFRA ART	OPIS
33500	MAGACIN TRAKA SVE BOJE
33504	MAGACIN ŠPAGA SVE BOJE



SIFRA ART	OPIS
50327	ULAZ ZA TRAKU SVE BOJE

## DM35S-10/17

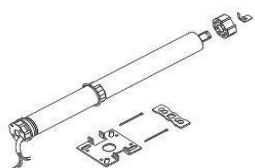

<b>SIFRA ART</b>	OPIS	
<b>38097</b>	MOTOR ZA ROLETNU	
Toegepassing met as   Utilisé avec un axe   Angewendet mit Welle   Applied with reel		SW 40
Totale lengte buismotor   Longueur total du moteur   Gesamtlänge des Antriebs   The total length of the motor		473 mm
Aantal omwentelingen / Werkingsijd   Nombre de tours / Temps du travail   Anzahl der Umdrehungen / Betriebszeit   Number of turns / Working time		17 min <sup>2</sup> / 4 min
Koppeling / Nominale stroom drijfwerk   Couple / Courant admissible   Drehmoment / Nennstrom des Antriebs   Torque / Motor rated current		10 Nm / 0,53 A
Vermogensverbruik / Voedingsspanning / Frequentie   Consommation électrique / Tension d'alimentation / fréquence   Kraftaufnahme / Versorgungsspannung / Frequenz   Power consumption / Power supply / Frequency		121 kW / 230 V AC / 50 Hz
Beschermingsgraad   Degrée de protection   Sicherungsgrad   Protection rating		IP 44

## DC115A



<b>SIFRA ART</b>	OPIS
<b>38101</b>	DALJINSKI 1 KANALA APF

## DC50

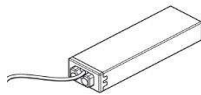

<b>SIFRA ART</b>	OPIS
<b>38090</b>	ZA MOTOR DM35S/17

## DC313

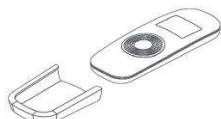

<b>SIFRA ART</b>	OPIS
<b>38099</b>	DALJINSKI 15 KANALA APF

## DC306



<b>SIFRA ART</b>	OPIS
<b>38098</b>	DALJINSKI 5 KANALA APF



<b>SIFRA ART</b>	OPIS
<b>38202</b>	SIGURNOSNI KONEKTOR APF



<b>SIFRA ART</b>	OPIS
<b>38203</b>	PRSTEN ZA SIG. KONEKTOR



Maks. kapacite  
Max. capacity

13 kg

**SIFRA ART**

OPIS

**32095**

REDUKOTOR



**SIFRA ART**

OPIS

**32097**

NASTAVAK ZA KURBLU



**SIFRA ART**

OPIS

**32157**

UMETAK ZA KURBLU AS



**SIFRA ART**

OPIS

**32193**

BEZ CIJEVI AS BIJELA



**SIFRA ART**

OPIS

**32192**

CIJEV ZA KURBLU 1600 AS



**SIFRA ART**

OPIS

**32096**

POKLOPAC ZA REDUKTOR AS

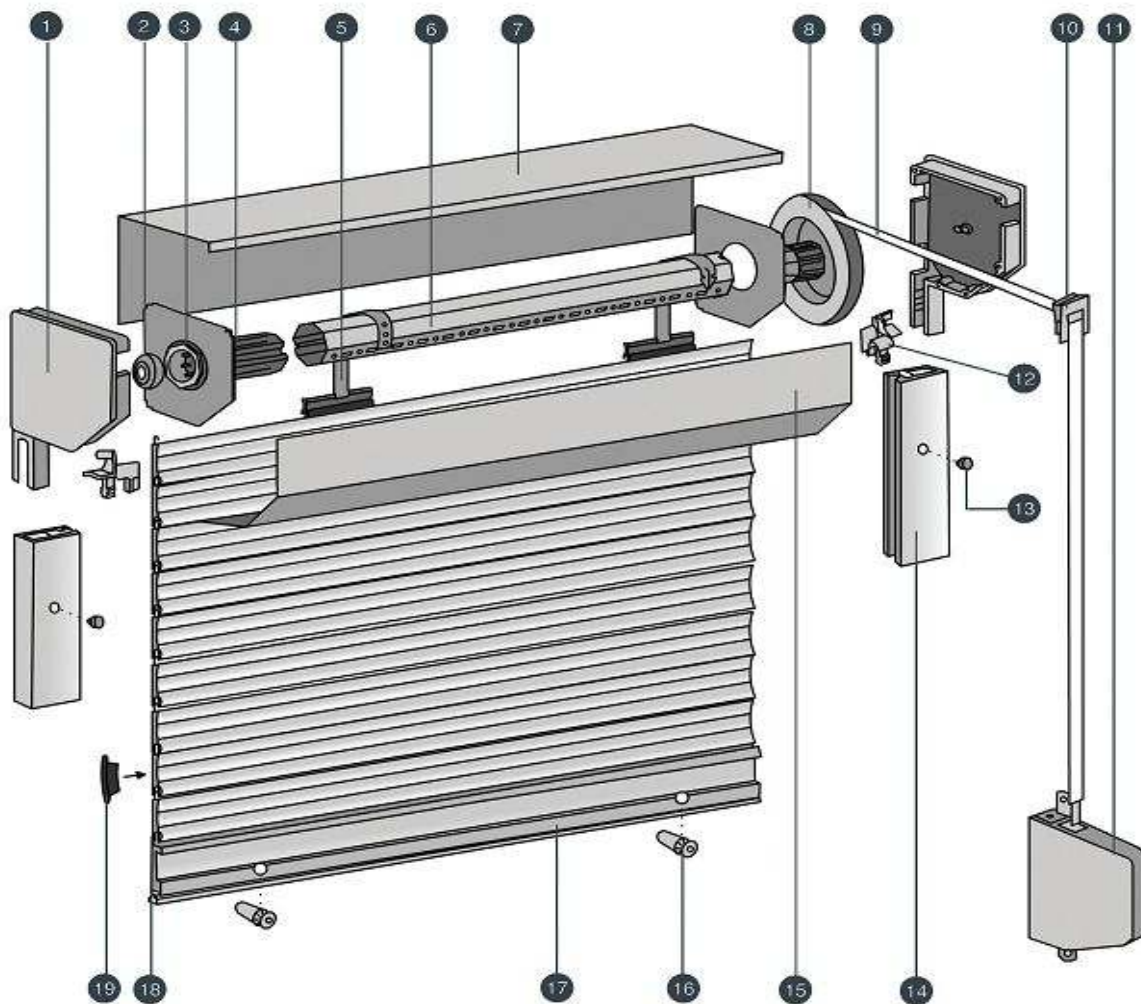

- |                        |                            |
|------------------------|----------------------------|
| 1-Deklo kutije         | 11-Magacin s trakom        |
| 2-Ležaj                | 12-Pvc vođica              |
| 3-Distnacer            | 13-Čep fi 10               |
| 4-Oktogonalni poklopac | 14-Kanal za vođenje        |
| 5-Konketor lamele      | 15-Prednji dio kutije      |
| 6-Oktogonalna cijev    | 16-Vanjski stoper          |
| 7-Zadnji dio kutije    | 17-Granični profil         |
| 8-Kotur za traku       | 18-Guma za granični profil |
| 9-Traka                | 19-Poklopac lamele         |
| 10-Ulaz za traku       |                            |

EURO-ROAL doo  
Sarajevska 17,  
74 203 Doboj Jug  
tel 032-692-518  
[info@euroroal.ba](mailto:info@euroroal.ba)

EURO-ROAL doo  
Garovci bb  
Hadžići  
tel 033-420-499  
[info1@euroroal.ba](mailto:info1@euroroal.ba)

EURO-ROAL doo  
Ostrožac bb  
Cazin  
tel 037-518-219  
[hase.h@euroroal.ba](mailto:hase.h@euroroal.ba)